

PART

NUMBER: LMX4644TN1

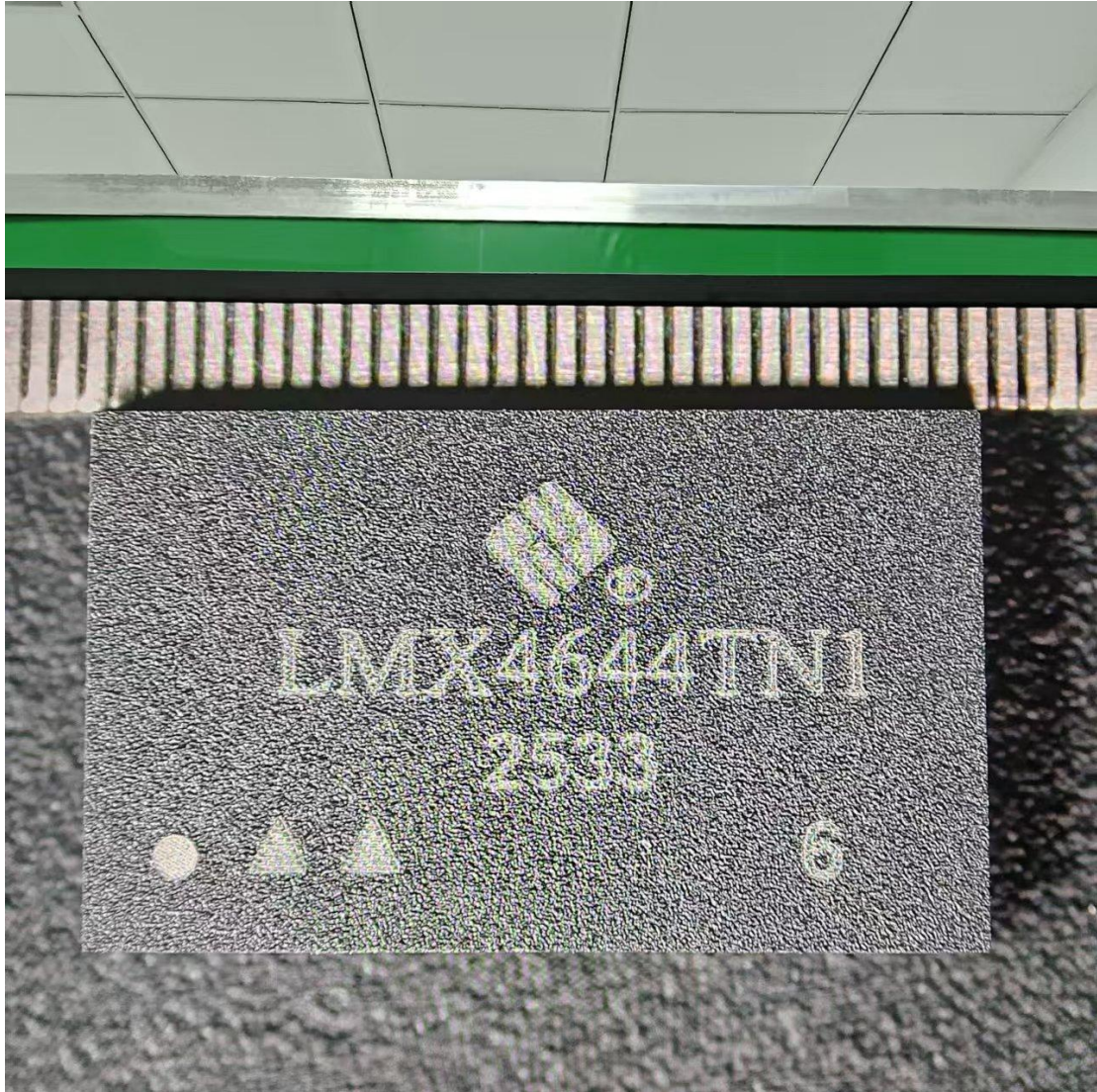

Product Features

- Each output provides up to 4A current
 - Wide input voltage range: 4V to 20V
 - Output voltage range: 0.6V to 5.5V
 - Each channel provides up to 4A DC, 5A peak output current
 - 1MHz operating frequency
 - Current-mode control with fast transient response
 - Parallel current sharing; single module can be paralleled for 16A output
 - Soft-start and output voltage tracking
 - External frequency synchronization
 - Overcurrent and overheat protection
-

Functional Description

The LMX4644TN1 is a four-channel step-down micro-module regulator in plastic packaging, capable of operating across the full temperature range. The control IC is fabricated using 0.18 μm BCD technology, housed in a BGA77 package with typical dimensions of 9mm \times 15mm \times 2.51mm. It operates within a typical ambient temperature range of -55°C to $+125^{\circ}\text{C}$. The input voltage range is 4V to 20V, and the output voltage range is 0.6V to 5.5V. It provides four-channel 4A current, and when the four channels are used in parallel, it can deliver up to 16A current on a single output.

The LMX46XX series products cover a wide range of variants, including standard versions, radiation-hardened versions, plastic-encapsulated and ceramic-encapsulated packages. They are available in multiple quality grades: industrial grade, extended temperature grade, M1 grade, and N1 grade, with 24 models in total.

All products are independently developed and designed using original forward architecture with wafer fabrication and packaging completed in China. They have obtained national certification for independent and controllable core technologies, successfully breaking the “bottleneck” in high-end power chip development.

These products serve as pin-to-pin replacements for the Linear Technology (ADI) LTM46XX series, while outperforming them in key parameters. The company attaches great importance to product quality and has established a comprehensive quality system, certified with ISO9001 and GJB9001C.

Supported by the rapid development of China’s semiconductor industry, Langma Innovation deeply serves domestic special industries and has delivered high-performance, high-precision, high-reliability, and cost-effective domestic chips in large volumes.

In the future, the company will continue to build a national leading brand, providing more comprehensive solutions for communications, radar, computing, artificial intelligence, automation, naval vessels, aviation, aerospace, and other equipment fields, and promoting industrial innovation and development.

典型应用原理图

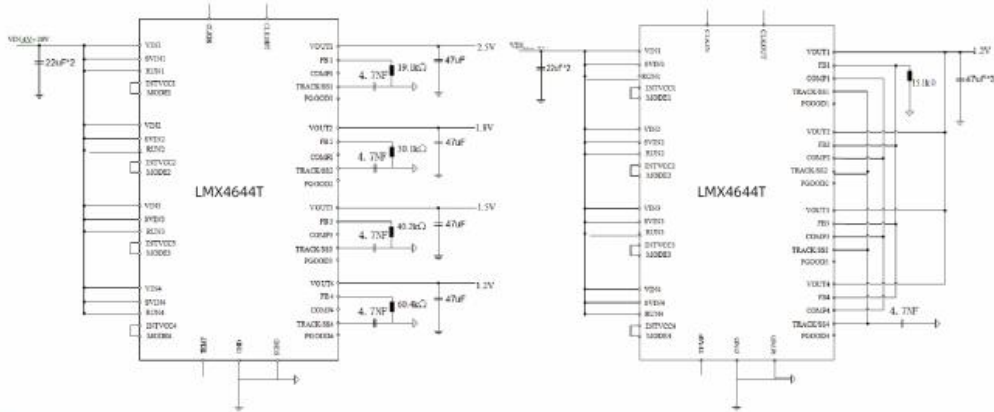

外形尺寸图

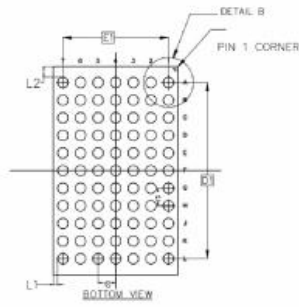
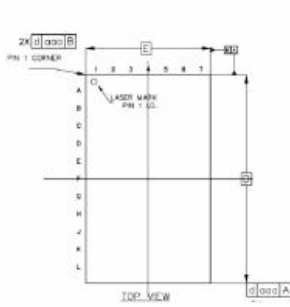

SYMBOL	MILLIMETER		
	MIN	NCM	MAX
A	2.41	2.51	2.61
A1	0.55	0.60	0.65
A2	1.86	1.91	1.96
A3	1.50 BASIC		
c	0.37	0.41	0.45
D	14.90	15.00	15.10
D1	12.7 BASIC		
E	8.90	9.00	9.10
E1	7.62 BASIC		
e	1.27 BASIC		
b	0.71	0.76	0.81
L1	0.31REF		
L2	0.77REF		
aaa	0.20		
ccc	0.12		
ddd	0.22		
eee	0.20		
fff	0.12		

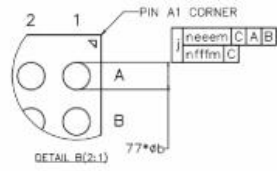
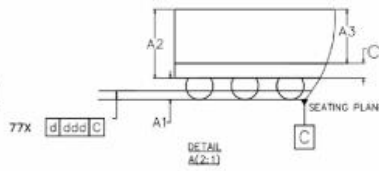
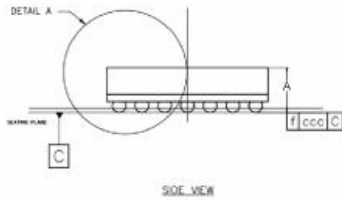

内部原理框图

